

# 7 DEALER MANUAL FOR DP C244.CAN/ DP C245.CAN

---



## CONTENT

---

<b>7.1 Important Notice</b> .....	<b>2</b>	<b>7.7.3 Multifunction Selection</b> .....	<b>7</b>
<b>7.2 Introduction of Display</b> .....	<b>2</b>	<b>7.7.4 Headlights / Backlighting</b> .....	<b>7</b>
<b>7.3 Product Description</b> .....	<b>3</b>	<b>7.7.5 Walk Assistance</b> .....	<b>7</b>
7.3.1 Specifications.....	3	<b>7.7.6 Battery Capacity Indication</b> .....	<b>8</b>
7.3.2 Functional Overview.....	3	<b>7.7.7 USB Charge Function</b> .....	<b>8</b>
<b>7.4 Display Installation</b> .....	<b>4</b>	<b>7.7.8 Bluetooth Function</b> .....	<b>8</b>
<b>7.5 Display</b> .....	<b>5</b>	<b>7.8 Settings</b> .....	<b>9</b>
<b>7.6 Key Definition</b> .....	<b>5</b>	7.8.1 "Display Setting".....	9
<b>7.7 Normal Operation</b> .....	<b>6</b>	7.8.2 "Information".....	11
7.7.1 Power ON/OFF.....	6	<b>7.9 Error Code Definition</b> .....	<b>13</b>
7.7.2 Power Assist Mode Selection.....	6	<b>7.10 Warn Code Definition</b> .....	<b>17</b>

# 7.1 IMPORTANT NOTICE

---

- If the error information from the display cannot be corrected according to the instructions, please contact your retailer.
- The product is designed to be waterproof. It is highly recommended to avoid submerging the display under water.
- Do not clean the display with a steam jet, high-pressure cleaner or water hose.
- Please use this product with care.
- Do not use thinners or other solvents to clean the display. Such substances can damage the surfaces.
- Warranty is not included due to wear and normal use and aging.

# 7.2 INTRODUCTION OF DISPLAY

---

- Model: DP C244.CAN/ DP C245.CAN
- The housing material is ABS; the LCD display windows is made of tempered glass:



- The label marking is as follows:



**i** **Note:** Please keep the QR code label attached to the display cable. The information from the Label is used for a later possible software update.

# 7.3 PRODUCT DESCRIPTION

---

## 7.3.1 Specifications

- Operating temperature: -20°C~45°C
- Storage temperature: -20°C~60°C
- Waterproof: IP65
- Storage Humidity: 30%-70% RH

## 7.3.2 Functional Overview

- CAN communication protocol
- Speed indication (including the real-time speed, max. speed and average speed)
- Unit switching between km and mile
- Battery capacity indicator
- Automatic sensors explanation of the lighting system
- Brightness setting for backlight
- 6 power assist modes
- Mileage indication (including single-trip distance TRIP and total distance ODO, the highest mileage is 99999)
- Intelligent indication (including remaining distance RANGE and energy consumption CALORIE)
- Error code indication
- Walk assistance
- USB charge (5V and 500mA)
- Service indication
- Bluetooth Function (only in DP C245.CAN)

# 7.4 DISPLAY INSTALLATION

1. Open the clamp of display and place the display on to the handlebar in the correct position. Now with M3\*8 screw C tighten the display. Torque requirement: 1N.m.

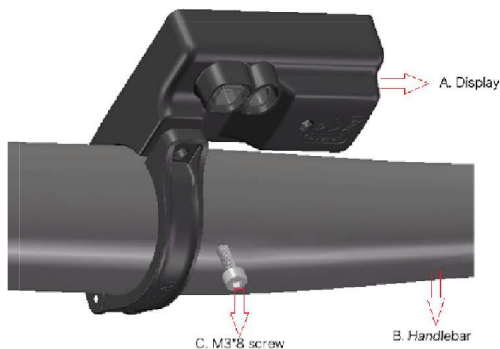

**i** Note: The diameter of display clamp is  $\Phi 35\text{mm}$ . According to the diameter of the handlebar you can choose whether to need a rubber ring ( $\Phi 22.2$ ,  $\Phi 25.4$  or  $\Phi 31.8$ ).

2. Open the clamp of control unit and place it on to the handlebar in the correct position. Now with M3\*8 screw C tighten the control unit. Torque requirement: 1N.m.

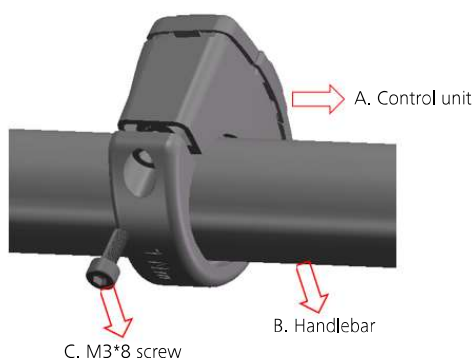

**i** Note: The diameter of control unit clamp is  $\Phi 22.2\text{mm}$ .

3. Connect the 5-pin EB-BUS connector and 6-pin control unit connector with the display main body.



## 7.5 DISPLAY



- 1 Headlight indication
- 2 USB charge indication
- 3 Service indication
- 4 Bluetooth indication  
(only light up in DP C245.CAN)
- 5 Power assist mode indication
- 6 Multifunction indication
- 7 Battery capacity indication
- 8 Speed in real-time

## 7.6 KEY DEFINITION



# 7.7 NORMAL OPERATION

## 7.7.1 Power ON/OFF



Press  and hold (>2S) to power on the HMI, and the HMI begin to show the boot up LOGO.

Press  and hold (>2S) again to power off the HMI.

If the automatic shutdown time is set to 5 minutes (set in function "Auto Off"), the HMI will be automatically turned off within this set time, when it is not operated.



## 7.7.2 Power Assist Mode Selection

When HMI powers on, briefly press  or  to select the power assist mode and change the output power. The lowest mode is E, the highest mode is B (which can be set). On the default is mode E, number "0" means no power assistance.

Mode	Color	Definition
Eco	green	the most economic mode
Tour	blue	the most economic mode
Sport	indigo	the sport mode
Sport+	red	the sport plus mode
Boost	purple	the strongest sport mode



### 7.7.3 Multifunction Selection

Briefly press  button to switch the different function and information.

Circularly show single trip distance (TRIP,km) → total distance (ODO,km) → maximum speed (MAX,km/h) → average speed (AVG,km/h) → remaining distance (Range,km) → riding cadence (Cadence,rpm) → energy consumption (Cal,KCal) → riding time (TIME,min) → cycle.



### 7.7.4 Headlights / Backlighting

Press and hold  (>2S) to turn on the headlight and reduce the backlight brightness.







Press and hold  (>2S) again to turn off the headlight and increase the backlight brightness.

The brightness of backlight can be set in function "Brightness" within 5 levels.



### 7.7.5 Walk Assistance

Note: The walk assistance can only be activated with a standing pedelec.

Briefly press  button until this symbol  appears. Next keep pressing the  button until the walk assistance is activated and the  symbol is flashing. (If no speed signal is detected, the real-time speed is shown as 2.5km/h.) Once releasing the  button, it will exit the walk assistance and the  symbol stops flashing. If no operation within 5s, the display will automatically return to 0 mode.



### 7.7.6 Battery Capacity Indication

The percentage of current battery capacity and total capacity is displayed from 100% to 0% according to the actual capacity.

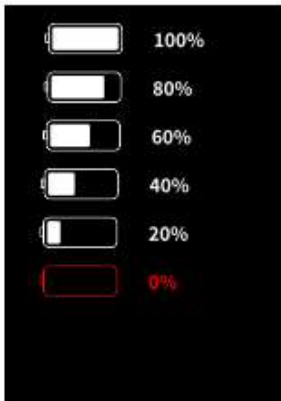

### 7.7.7 USB Charge Function

When the HMI is off, insert the USB device to the USB charging port on the HMI, and then turn on HMI to charge. When the HMI is on, it can direct charge for USB device. the maximum charging voltage is 5V and the maximum charging current is 500mA.



### 7.7.8 Bluetooth Function

Note: Only DP C245.CAN is the Bluetooth version.

DP C245 equipped with Bluetooth 5.1 can be connected to the Bafang Go+ APP.

This display can be connected to the SIGMA heartbeat band and shows it on display, and can also send data to the mobile phone.

The data that can be sent to the mobile phone are as follow:

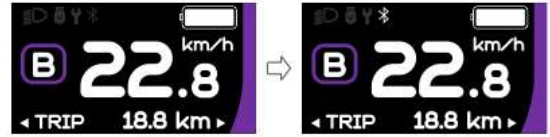

No.	Function
1	Speed
2	Battery capacity
3	Support level
4	Battery info.
5	Sensor signal
6	Remaining distance
7	Energy consumption
8	System part info.
9	Current
10	Heartbeat
11	Single distance
12	Total distance
13	Headlight status
14	Error code



(Bafang Go+ for Android™ and iOS™ )



# 7.8 SETTINGS

After the HMI powered on, press and hold ▲ and ▼ button (at the same time) to enter into the setting interface. Briefly press (<0.5S) ▲ or ▼ button to select "Setting", "Information" or "Exit", then briefly press (<0.5S) ⏻ button to confirm.

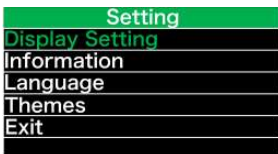

## 7.8.1 "Setting" interface

After the HMI powered on, press and hold ▲ and ▼ button to enter into the setting interface. Briefly press (<0.5S) ▲ or ▼ to select "Setting" and then briefly press ⏻ (<0.5S) to confirm.

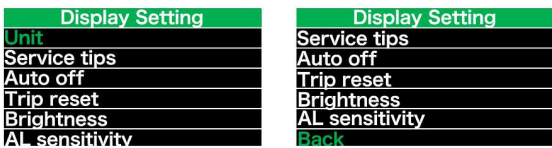

### 7.8.1.1 "Unit" Selections in km/Miles

Briefly press ▲ or ▼ to select "Unit", and briefly press ⏻ to enter into the item. Then choose between "Metric" (kilometer) or "Imperial" (mile) with the ▲ or ▼ button. Once you have chosen your desired selection, press the ⏻ button (<0.5S) to save and exit back to the "Setting" interface.



Note: If you choose "Metric", all the data displayed on the HMI are metric.

### 7.8.1.2 "Auto Off" Set automatic Off time

Briefly press ▲ or ▼ to select "Auto Off", and briefly press ⏻ to enter into the item.

Then select the automatic Off time as "OFF"/"1"/"2"/"3"/"4"/"5"/"6"/"7"/"8"/"9"/"10" with the ▲ or ▼ button. Once you have chosen your desired selection, press the ⏻ button (<0.5S) to save and exit back to the "Setting" interface.



Note: "OFF" means the "Auto Off" function is off.

### 7.8.1.3 "Brightness" Display brightness

Briefly press ▲ or ▼ to select "Brightness", and briefly press ⏻ to enter into the item. Then select the percentage as "100%" / "75%" / "50%" / "25%" with the ▲ or ▼ button. Once you have chosen your desired selection, press the ⏻ button (<0.5S) to save and exit back to the "Setting" interface.



### 7.8.1.4 "AL Sensitivity" Set light sensitivity

Briefly press ▲ or ▼ to select "AL Sensitivity", and briefly press ⏻ to enter into the item. Then select the level of the light sensitivity as "OFF"/"1"/"2"/"3"/"4"/"5" with the ▲ or ▼ button. Once you have chosen your desired selection, press the ⏻ button (<0.5S) to save and exit back to the "Setting" interface.

Note: "OFF" means light sensor is off. Level 1 is the weakest sensitivity and level 5 is the strongest sensitivity.

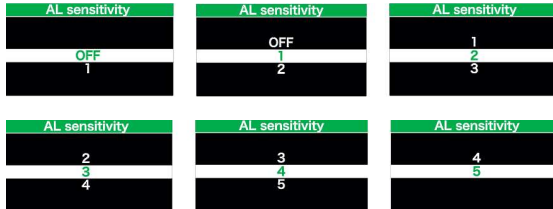

### 7.8.1.5 "TRIP Reset" Set reset function for single-trip

Briefly press or to select "TRIP Reset", and briefly press to enter into the item. Then select "NO"/"YES" ("YES"-to clear, "NO"-no operation) with the or button. Once you have chosen your desired selection, press the (<0.5S) to save and exit back to the "Setting" interface.

Note: The riding time(TIME), average speed (AVG) and maximum speed (MAXS) will be reset simultaneously when you reset TRIP.



### 7.8.1.6 "Service" Turn on/off the Service indication

Briefly press or to select "Service", and briefly press to enter into the item. Then select "OFF"/"ON" ("ON" means Service indication is on; "OFF" means Service indication is off) with the or button. Once you have chosen your desired selection, press the (<0.5S) to save and exit back to the "Setting" interface.

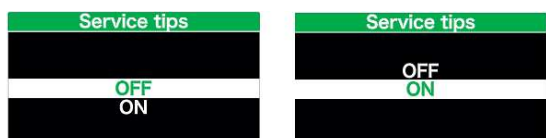

Note: The default setting is OFF. If the ODO is more than 5000 km, the "Service" indication and mileage indication will flash for 4S.



## 7.8.2 "Information"

After the HMI powered on, press and hold and to enter into the setting function. Briefly press (<0.5S) or to select "Information" and then briefly press (<0.5S) to confirm.



**Note:** All information here cannot be changed, it is to be viewed only.

### 7.8.2.1 "Wheel Size"

After entering the "Information" page, you can see "Wheel Size --Inch" directly.



### 7.8.2.2 "Speed Limit"

After entering the "Information" page, you can see "Speed Limit --km/h" directly.



### 7.8.2.3 "Battery Info"

Briefly press or to select "Battery Info", and briefly press to enter, then briefly press or to view the battery data (b01 → b04 → b06 → b07 → b08 → b09).

→ b10 → b11 → b12 → b13 → d00 → d01 → d02 → ... → dn).

Press the  button (<0.5S) to exit back to the "Information" interface.

Note: If the battery doesn't have communication function, you won't see any data from battery.

View the battery information



View the hardware and software version of battery

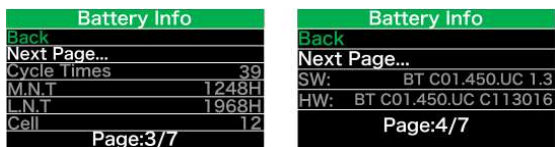





Code	Code Definition	Unit
b01	Current temperature	°C
b04	Battery voltage	mV
b06	Current	mA
b07	Remaining battery capacity	mAh
b08	Battery capacity of Full charged	mAh
b09	Relative SOC	%
b10	Absolute SOC	%
b11	Cycle Times	times
b12	Max Uncharge Time	Hour
b13	Last Uncharge Time	Hour

Code	Code Definition	Unit
d00	The number of cell	
d01	Voltage Cell 1	mV
d02	Voltage Cell 2	mV
dn	Voltage Cell n	mV

NOTE: If no data is detected, "--" will be displayed.





### 7.8.2.4 "Display Info"

Briefly press  or  to select "Display Info", and briefly press  to enter, briefly press  or  to view "Hardware Ver" or "Software Ver".

Press the  button (<0.5S) to exit back to the "Information" interface.







### 7.8.2.5 "Ctrl Info"

Briefly press  or  to select "Ctrl Info", and briefly press  to enter, briefly press  or  to view "Hardware Ver" or "Software Ver".

Press the  button (<0.5S) to exit back to the "Information" interface.



### 7.8.2.6 "Sensor Info"





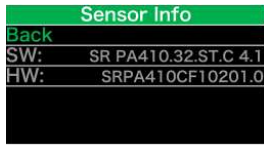

Briefly press  or  to select "Sensor Info", and briefly press  to enter, briefly press  or  to view "Hardware Ver" or "Software Ver".

Press the  button (<0.5S) to exit back to the "Information" interface.



**NOTE:** If your Pedelec doesn't have torque sensor, "--" will be displayed.

### 7.8.2.7 "Error Code"

Briefly press  or  to select "Error Code", and then briefly press  to enter, briefly press  or  to view message of error for last ten times by "E-Code00" to "E-Code09". Press the  button (<0.5S) to exit back to the "Information" interface.



# 7.9 ERROR CODE DEFINITION

 The HMI can show the faults of Pedelec. When a fault is detected, one of the following error codes will be indicated too.



**Note:** Please read carefully the description of the error code. When the error code appears, please first restart the system. If the problem is not eliminated, please contact your dealer or technical personnel.

Error	Declaration	Troubleshooting
04	The throttle has fault.	<ol style="list-style-type: none"> <li>1. Check the connector and cable of the throttle are not damaged and correctly connected.</li> <li>2. Disconnect and reconnect the throttle, if still no function please change the throttle.</li> </ol>
05	The throttle is not back in its correct position.	Check the connector from the throttle is correctly connected. If this does not solve the problem, please change the throttle.
07	Overvoltage protection	<ol style="list-style-type: none"> <li>1. Remove and re-Insert the battery to see if it resolves the problem.</li> <li>2. Using the BESST tool update the controller.</li> <li>3. Change the battery to resolve the problem.</li> </ol>
08	Error with the hall sensor signal inside the motor	<ol style="list-style-type: none"> <li>1. Check all connectors from the motor are correctly connected.</li> <li>2. If the problem still occurs, please change the motor.</li> </ol>
09	Error with the Engine phase's	Please change the motor.
10	The temperature inside the engine has reached its maximum protection value	<ol style="list-style-type: none"> <li>1. Turn off the system and allow the Pedelec to cool down.</li> <li>2. If the problem still occurs, please change the motor.</li> </ol>
11	The temperature sensor inside the motor has an error	Please change the motor.
12	Error with the current sensor in the controller	Please change the controller or contact your supplier.

Error	Declaration	Troubleshooting
13	Error with the temperature sensor inside of the battery	<ol style="list-style-type: none"> <li>1. Check all connectors from the battery are correctly connected to the motor.</li> <li>2. If the problem still occurs, please change the Battery.</li> </ol>
14	The protection temperature inside the controller has reached its maximum protection value	<ol style="list-style-type: none"> <li>1. Allow the pedelec to cool down and restart the system.</li> <li>2. If the problem still occurs, please change the controller or contact your supplier.</li> </ol>
15	Error with the temperature sensor inside the controller	<ol style="list-style-type: none"> <li>1. Allow the pedelec to cool down and restart the system.</li> <li>2. If the problem still occurs, Please change the controller or contact your supplier.</li> </ol>
21	Speed sensor Error	<ol style="list-style-type: none"> <li>1. Restart the system</li> <li>2. Check that the magnet attached to the spoke is aligned with the speed sensor and that the distance is between 10 mm and 20 mm.</li> <li>3. Check that the speed sensor connector is connected correctly.</li> <li>4. Connect the pedelec to BESST, to see if there is a signal from the speed sensor.</li> <li>5. Using the BESST Tool- update the controller to see if it resolves the problem.</li> <li>6. Change the speed sensor to see if this eliminates the problem. If the problem still occurs, please change the controller or contact your supplier.</li> </ol>
25	Torque signal Error	<ol style="list-style-type: none"> <li>1. Check that all connections are connected correctly.</li> <li>2. Please connect the pedelec to the BESST system to see if torque can be read by the BESST tool.</li> <li>3. Using the BESST Tool update the controller to see if it resolves the problem, if not please change the torque sensor or contact your supplier.</li> </ol>

Error	Declaration	Troubleshooting
26	Speed signal of the torque sensor has an error	<ol style="list-style-type: none"> <li>1. Check that all connections are connected correctly.</li> <li>2. Please connect the pedelec to the BESST system to see if speed signal can be read by the BESST tool.</li> <li>3. Change the Display to see if the problem is solved.</li> <li>4. Using the BESST Tool update the controller to see if it resolves the problem, if not please change the torque sensor or contact your supplier.</li> </ol>
27	Overcurrent from controller	Using the BESST tool update the controller. If the problem still occurs, please change the controller or contact your supplier.
30	Communication problem	<ol style="list-style-type: none"> <li>1. Check all connections on the pedelec are correctly connected.</li> <li>2. Using the BESST Tool run a diagnostics test, to see if it can pinpoint the problem.</li> <li>3. Change the display to see if the problem is solved.</li> <li>4. Change the EB-BUS cable to see if it resolves the problem.</li> <li>5. Using the BESST tool, re-update the controller software. If the problem still occurs please change the controller or contact your supplier.</li> </ol>
33	Brake signal has an error (If brake sensors are fitted)	<ol style="list-style-type: none"> <li>1. Check all connectors are correctly connected on the brakes.</li> <li>2. Change the brakes to see if the problem is solved.</li> </ol> <p>If problem continues Please change the controller or contact your supplier.</p>
35	Detection circuit for 15V has an error	Using the BESST tool update the controller to see if this resolves the problem. If not, please change the controller or contact your supplier.
36	Detection circuit on the keypad has an error	Using the BESST tool update the controller to see if this resolves the problem. If not, please change the controller or contact your supplier.

Error	Declaration	Troubleshooting
37	WDT circuit is faulty	Using the BESST tool update the controller to see if this resolves the problem. If not, please change the controller or contact your supplier.
41	Total voltage from the battery is too high	Please change the battery.
42	Total voltage from the battery is too low	Please Charge the battery. If the problem still occurs, please change the battery.
43	Total power from the battery cells is too high	Please change the battery.
44	Voltage of the single cell is too high	Please change the battery.
45	Temperature from the battery is too high	Please let the pedelec cool down. If problem still occurs, please change the battery.
46	The temperature of the battery is too low	Please bring the battery to room temperature. If the problem still occurs, please change the battery.
47	SOC of the battery is too high	Please change the battery.
48	SOC of the battery is too low	Please change the battery.
61	Switching detection defect	1. Check the gear shifter is not jammed. 2. Please change the gear shifter.
62	Electronic derailleur cannot release.	Please change the derailleur.
71	Electronic lock is jammed	1. Using the BESST tool update the Display to see if it resolves the problem. 2. Change the display if the problem still occurs, please change the electronic lock.
81	Bluetooth module has an error	Using the BESST tool, re-update the software onto the display to see if it resolves the problem. If not, Please change the display.



# 7.10 WARN CODE DEFINITION

---

Warn	Declaration	Troubleshooting
28	Torque sensor's initialization is abnormal.	Restart the system and note not to step on the crank hard when restarting.

DEALER MANUAL FOR DISPLAY